

8550
0.952 kg/m
(Üst-Yan Kasa)

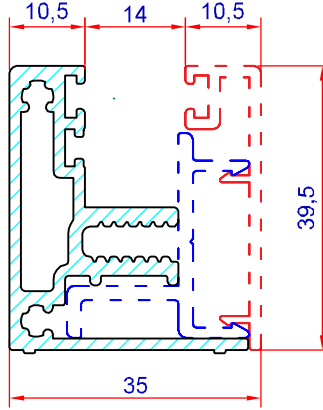

8551
0.788 kg/m
(Alt Kasa)

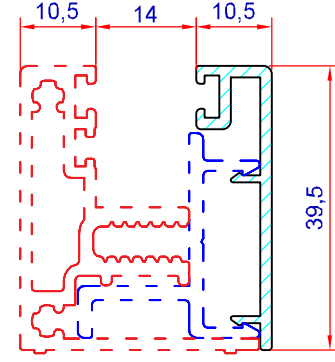

8552
0.281 kg/m
(Alt Kasa Kapak)

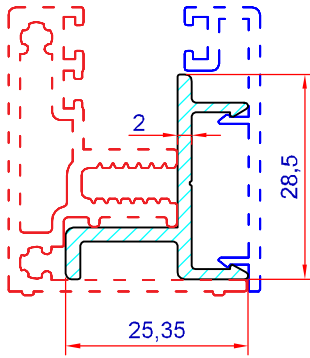

8553
0.325 kg/m
(Cam Klips)

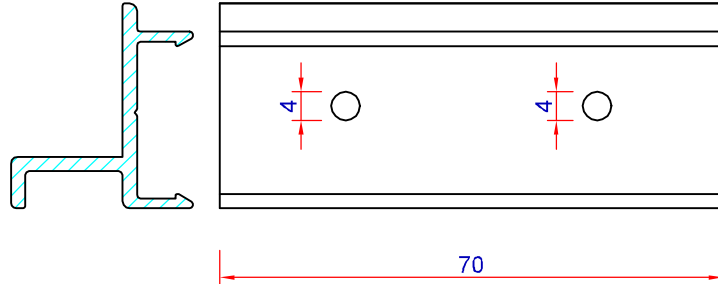

(30 cm Aralıklarla montajı yapılır.)
(Cam Klips kesi ve delme detayı)

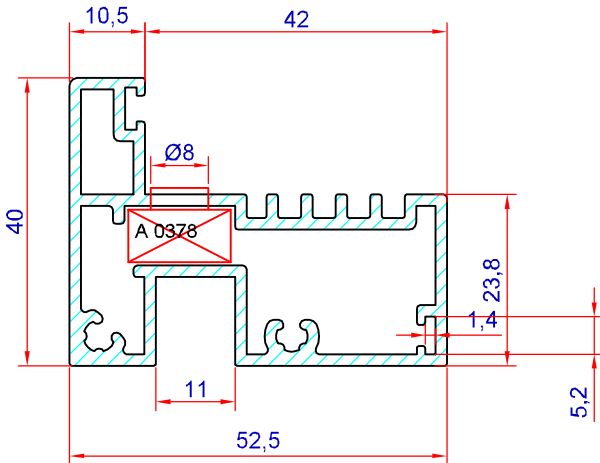

8554
1.143 kg/m
(Kapı kasa)

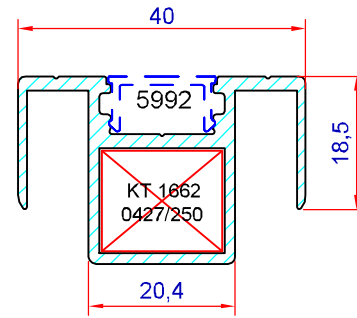

8557
0.623 kg/m
(Cam-Panel Kapı kanat)

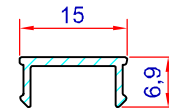

5992
0.080 kg/m

